

THE COVENANT GROUP
37 LOUELLA DRIVE
HEBRON, OH

RECEIVED
MAR 28 2016
GC PLANNING COMMISSION

CANAAN LAND FWB CHURCH
2777 GANTZ ROAD
GROVE CITY, OHIO

REVISIONS

DATE
12-28-15

301

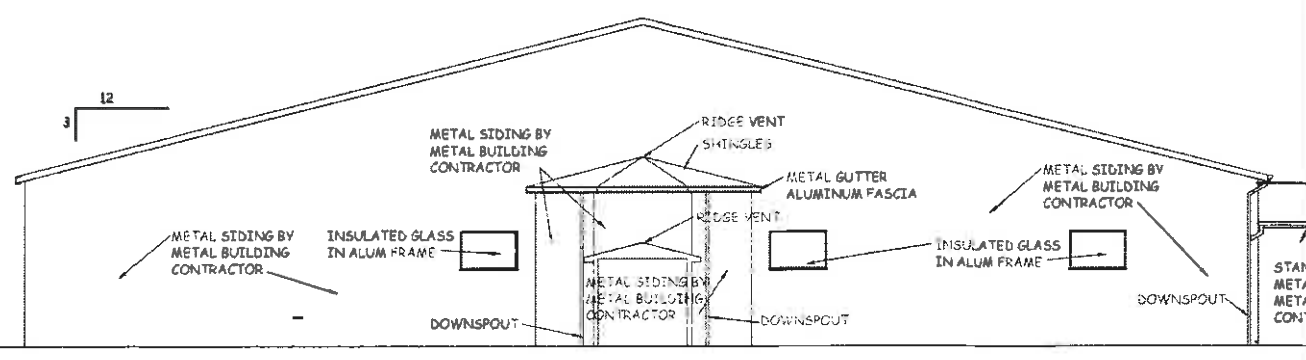
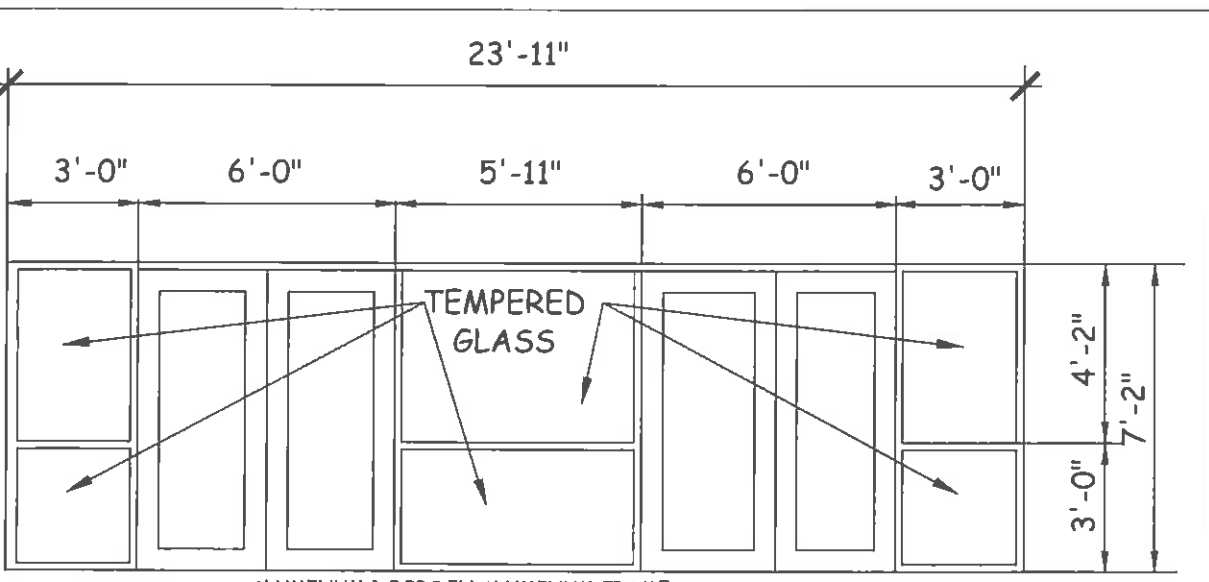
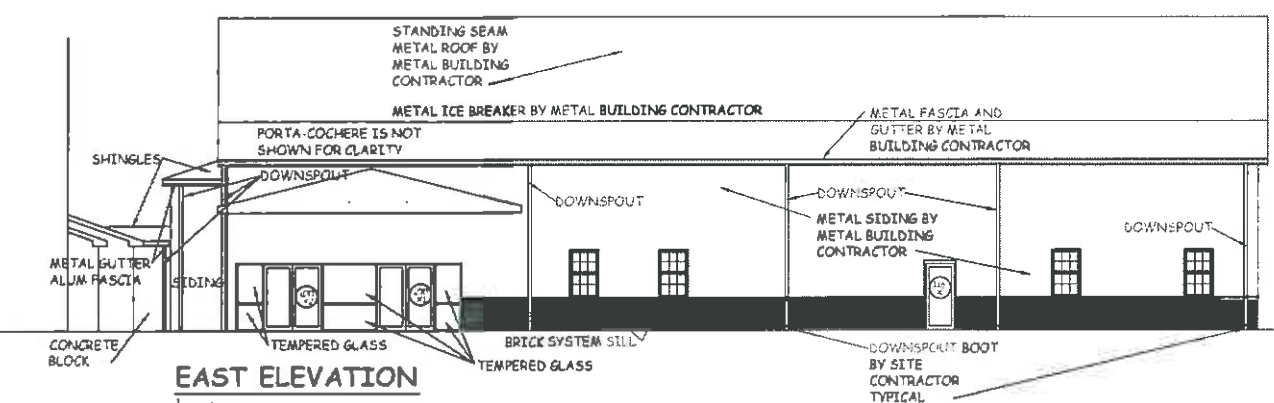
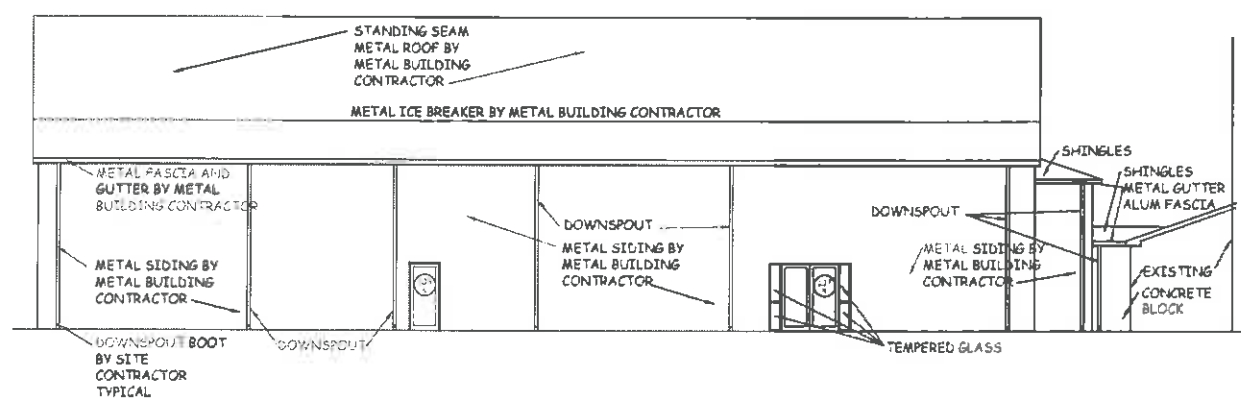
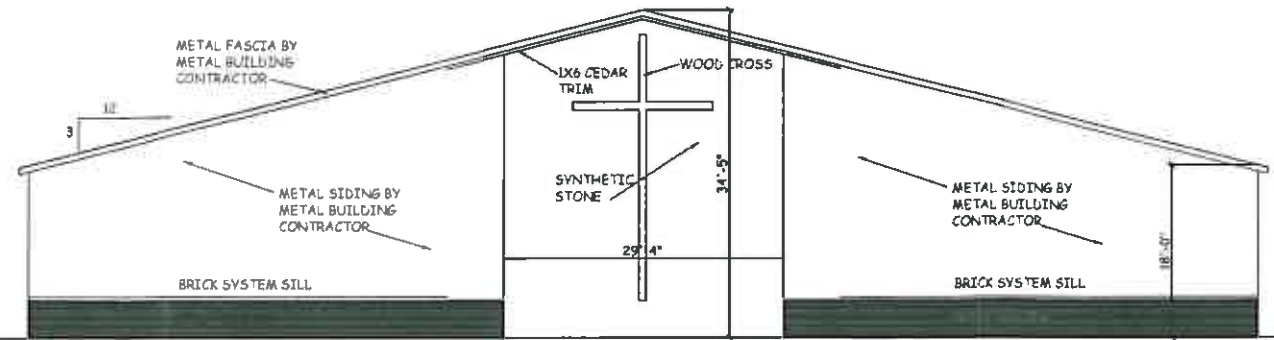
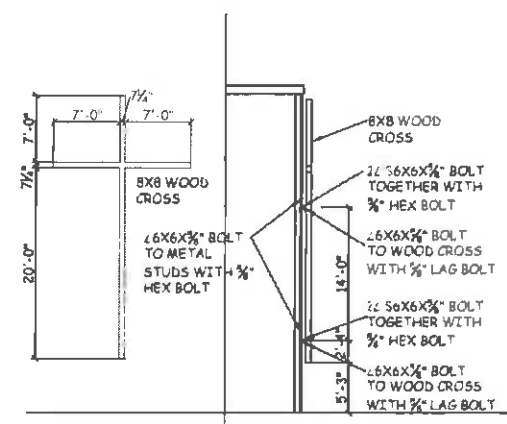
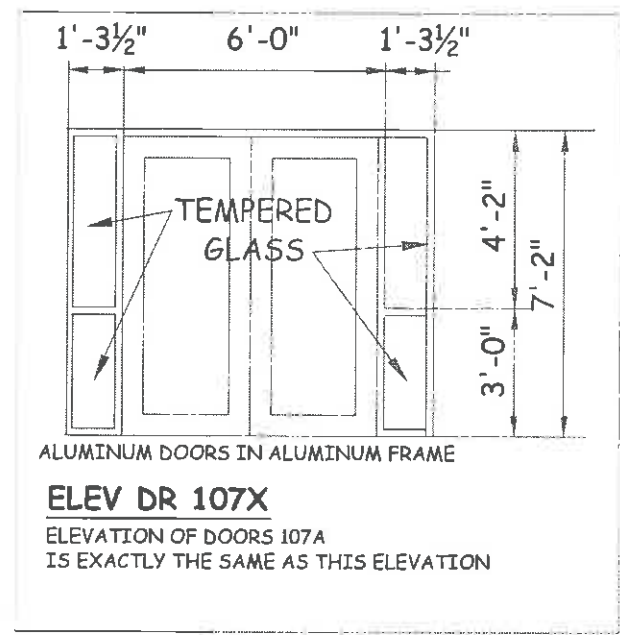

SPECIFICATION ON BRICK SIDING SYSTEM
BRICK SIDING TO BE REDLAND SIDING SYSTEMS INC TRU-BRIX REAL BRICK SIDING P O BOX 160 WILLIAMSPORT, MD 21795 WEIGHT: 11.5 POUNDS PER SQUARE FOOT BRICK SIZE: 2 1/4" X 7 5/8" X 1" BRICK COURSE: 3 COURSES-8" BRICK SPEC: ASTM C1088 THIN BRICK GRADE EXTERIOR (SEVERE WEATHERING) MORTAR: ASTM C270 TYPE N MORTAR CEMENT WITH POLYMER ADDITIVES FOR WORKABILITY AND DURABILITY

STEEL HOLDING RAILS: 0.027" HDG. COMMERCIAL CS TYPE B NON-CHEMICAL TREATED MINIMUM SPANGLER SMOOTH COLD ROLL FORMED G-90 GALVANIZING 50 YEAR PROPRIETARY PROTECTIVE POLYMERIC COATING ANCHORS: TYPE 2 SELF-TAPPING POLYMER COATED METAL SCREWS 1/4" FLASHING: SELF-ADHESIVE PVC 20 MIL HOUSE WRAP: PROPRIETARY "TRU-BRIX" DRAINAGE-TYPE WRAP MANUFACTURED HOUSE WRAP: PROPRIETARY "TRU-BRIX" DRAINAGE-TYPE WRAP MANUFACTURED